

Go Pro 50 ITA | 15W

Product Reference

Environment Indoor

Installation Track Mounted

Construction & Materials

Housing Die Cast Aluminium

Primary Lens PMMA

Primary Reflector -

Secondary Reflector Anodised

Body Finish White,Black

Diffuser -

Antiglare Baffle -

Thermal Management

Heat Sink Material Die cast Aluminium

Cooling Technique Passive Cooling

Optical System

Beam Direction Adjustable

Tilt Yes

Swivel Yes

Electrical System

Driven with Constant Current Driver

Input Voltage/Hz 220V- 240V/50-60Hz

Control Gear Included

Mounting Integral

LED Power Watts 12.4W

System Power Watts 14.2W

Operating Voltage V_{in} 220-240 Vac

Power Factor p.f. > 0.95

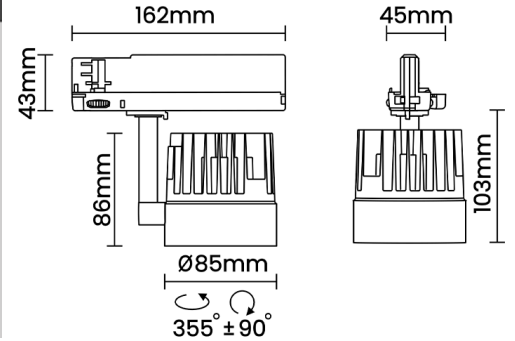

Light Distribution

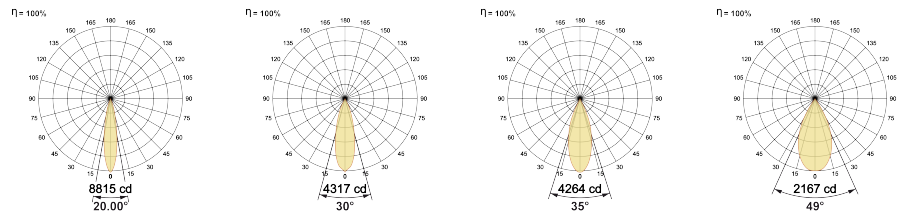

LED Technology

Binning 3 Step MacAdam

LED Life Time @ L80/B10 >50000 hours

Colour Rendering (CRI) CRI80,CRI90

Led Type COB

LED Fitted CREE COB LED 36Vdc/350mA

Controls

Standard Switchable On/Off

Optional Non Dimmable

Ordering Details

Code Example:	Name	Watt	CCT	CRI	Angle	Finish	Control
	Go Pro 50 ITA	15W	WW27K	CRI80	20°(SS)	SWH	On/Off

Select one from each column with highlighted values to create the ordering code

NAME	WATT	LUMEN	EFFICACY	CCT	CRI	ANGLE	FINISH	CONTROL	
Go Pro 50 ITA	15W	1392	98	2700K	WW27K	CRI80	20°(SS)	White SWH	Non Dimmable On/Off
		1434	101	3000K	WW30K	CRI90	30°(MD)	Black SBL	
		1505	106	4000K	NW40K		35°(WD)		
		1534	108	5700K	CW57K		49°(VWD)		
Go Pro 50 ITA	15W			WW27K	CRI80	20°(SS)	SWH	On/Off	