

# Peeping Tom SF | 5W

## Product Reference

Environment Indoor

Installation Ceiling Surface

## Construction & Materials

Housing Die Cast Aluminium, Milled Aluminium

Primary Lens PMMA

Primary Reflector PC metallised

Secondary Reflector -

Body Finish White, Black, Custom

Diffuser -

Antiglare Baffle -

## Thermal Management

Heat Sink Material Die cast Aluminium

Cooling Technique Passive Cooling

## Optical System

Beam Direction Adjustable

Tilt Yes

Swivel Yes

## Electrical System

Driven with Constant Current Driver

Input Voltage/Hz 220V- 240V/50-60Hz

Control Gear Included

Mounting Remote

LED Power Watts 3.7W

System Power Watts 4.2W

Operating Voltage Vin 220-240 Vac

Power Factor p.f. > 0.5

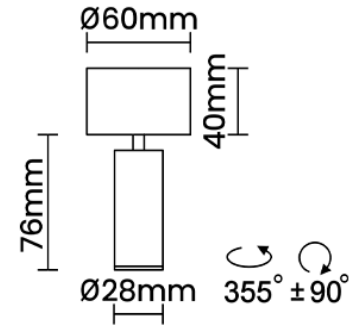

## Light Distribution

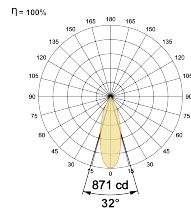

## LED Technology

Binning 3 Step MacAdam

LED Life Time @ L80/B10 >50000 hours

Colour Rendering (CRI) CRI80, CRI90

Led Type COB

LED Fitted CREE COB LED 36Vdc/130mA

## Controls

Standard Switchable On/Off

Optional Non Dimmable

## Ordering Details

Code Example:	Name	Watt	CCT	CRI	Angle	Finish	Control
	<b>Peeping Tom SF</b>	<b>5W</b>	<b>WW27K</b>	<b>CRI80</b>	<b>32°(MD)</b>	<b>SWH</b>	<b>On/Off</b>

Select one from each column with highlighted values to create the ordering code

NAME	WATT	LUMEN	EFFICACY	CCT	CRI	ANGLE	FINISH	CONTROL
<b>Peeping Tom SF</b>	<b>5W</b>	361	86	2700K <b>WW27K</b>	<b>CRI80</b>	32°(MD)	White <b>SWH</b>	Non Dimmable <b>On/Off</b>
		382	91	3000K <b>WW30K</b>	CRI90		Black <b>SBL</b>	
		403	96	4000K <b>NW40K</b>			Custom <b>CSM</b>	
		416	99	5700K <b>CW57K</b>				
<b>Peeping Tom SF</b>	<b>5W</b>			<b>WW27K</b>	<b>CRI80</b>	<b>32°(MD)</b>	<b>SWH</b>	<b>On/Off</b>